

NUOVO LG-400-N 70 KG

Il nuovo carrello progettato per ante fino a 70 Kg.
Presenta un profilo alto solamente 64 mm per vetri da 8/10 mm.

New trolley designed for panels up to 70 Kg.
Glass profile height only 64 mm, for glass 8/10 mm.

Neuer Laufwagen für Türen bis 70 Kg.
Glasprofilhöhe nur 64 mm für 8/10 mm Glas.

PLUS

PATENT
PENDING



6 Antisollevamento delle ante integrato nel carrello per una sicurezza assoluta ed una semplicità di rimozione, nel caso di manutenzione, grazie al nuovo brevetto Metalglas.

Anti-lifting doors integrated into the trolley for absolute safety and easy removal, in the event of maintenance, thanks to the new Metalglas patent.

Im Wagen ist ein System integriert, das ein Anheben der Türen verhindert. Es sorgt für absolute Sicherheit und garantiert ein einfaches Entfernen für die Wartung. Dies ist dem neuen Patent von Metalglas zu verdanken.

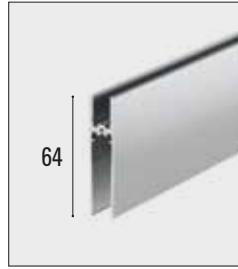

1 Una ruota per carrello per ante fino a 70 Kg.

One wheel for trolley for panels up to 70 Kg of glass.
Ein Rad pro Wagen für Glas einem Gewicht von bis zu 70 kg.

LG-400			LG-400-8		
70 Kg	10	950	70 Kg	8	950
		2700			2700



2 Facile regolazione in altezza delle ante.

The new trolley also facilitates height adjustment of the doors.

Der neue Wagen ermöglicht außerdem das leichte Einstellen der Höhe der Türen.



3 Basta tagliare il profilo a misura ed infilare i due carrelli ed il gioco è fatto. Nessuna lavorazione sui profili per questo sistema fantastico ed innovativo.

Just cut the profile to size and slide in the two carts, that's it! No further processing is required on the profiles for this fantastic and innovative system.

Dazu reicht es aus, das Profil nach Maß zuzuschneiden und die zwei Wägen einzufügen. Schon ist die Arbeit erledigt. Keine Arbeit an den Profilen dank dieses fantastischen und innovativen Systems.

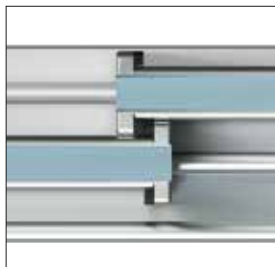

4 Mai più destro o sinistro. Un unico accessorio per tutte le tipologie di apertura.

No longer left or right, a single accessory for all types of openings.

Nie mehr rechts oder links - ein einziges Werkzeug für alle Öffnungsrichtungen.



5 Un altro vantaggio estetico e tecnico è il catenacciolo integrato nel carrello. Semplicità e velocità di applicazione.

Another aesthetic and technical advantage is the locking latch integrated into the trolley. Simplicity and speed of application.

Ein weiterer ästhetischer und technischer Vorteil besteht im Schließbolzen, der in den Wagen integriert ist. Einfache und schnelle Anwendung.

LOGGIAGLAS LG-400-N

- Sistema scorrevole telescopico studiato per balconi, logge e verande.
- Telescopic sliding system for balconies, loggias and terraces.
- Teleskop Schiebetürsystem für Balkon und Loggiaverglasungen.





- Sistema scorrevole telescopico studiato per balconi, logge e verande, ideale per proteggersi da vento e intemperie. Sistema con guida a terra.
- Telescopic sliding system for balcony, Loggia and terrace, ideal for wind and weather protection. System with bottom guide.
- Teleskop Schiebetürsystem für Balkon und Loggiaverglasungen, ideal für Wind-und Wetterschutz. System mit Bodenführung.

LG-400-N-SET 2 ▶ 168

- Sistema 2 ante telescopiche
- System for 2 telescopic doors
- System mit 2 Teleskoptüren

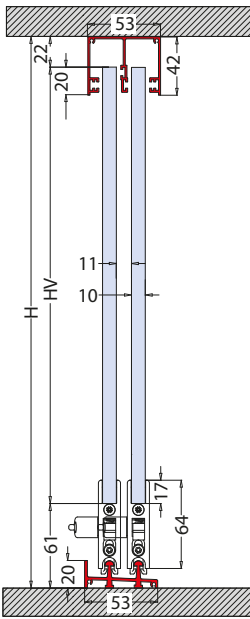

LG-400-N-SET 3 ▶ 170

- Sistema 3 ante telescopiche
- System for 3 telescopic doors
- System mit 3 Teleskoptüren

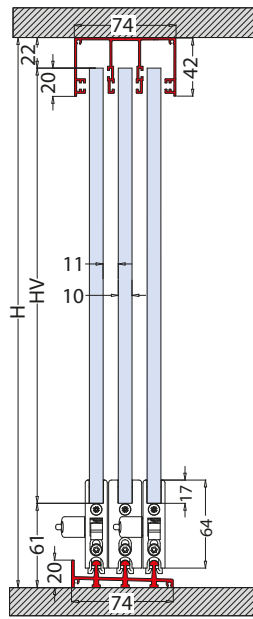

LG-400-N-SET 4 ▶ 172

- Sistema 4 ante telescopiche
- System for 4 telescopic doors
- System mit 4 Teleskoptüren

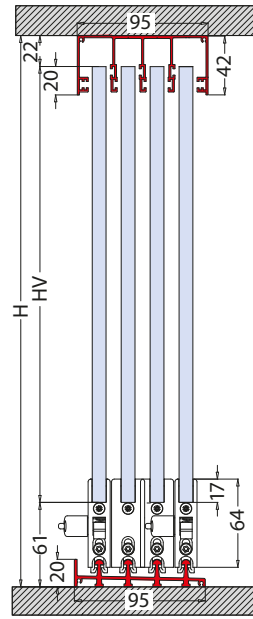

LG-400-N-SET 5 ▶ 174

- Sistema 5 ante telescopiche
- System for 5 telescopic doors
- System mit 5 Teleskoptüren

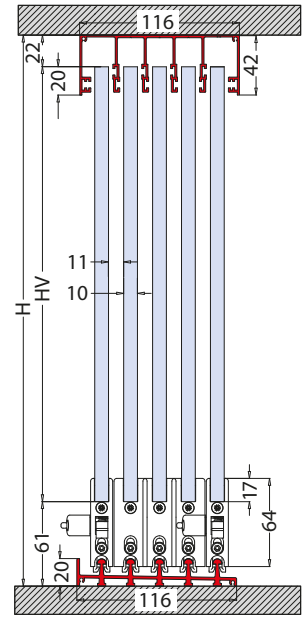

- Possibilità di installare guida a terra incassata nel pavimento o guida in appoggio con profili a scivolo
- Ability to install a similar rail embedded in the floor or bottom rail with ramp profiles
- Möglichkeit eine Führungsschiene in den Boden einzubauen oder Bodenschiene mit Profil Rampe

LG-410-N-SET 2

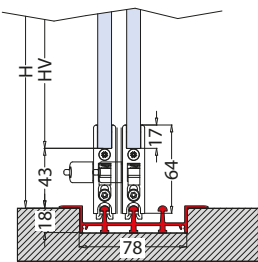

LG-410-N-SET 3

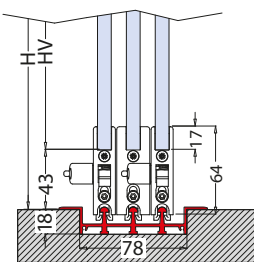

LG-410-N-SET 4

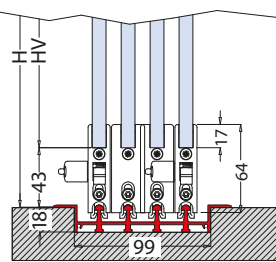

LG-410-N-SET 5

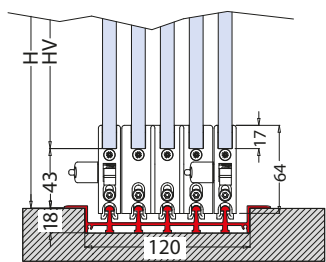

LG-420-N-SET 2

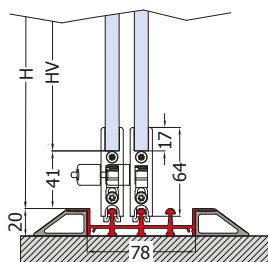

LG-420-N-SET 3

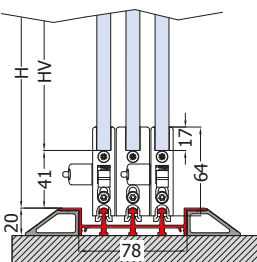

LG-420-N-SET 4

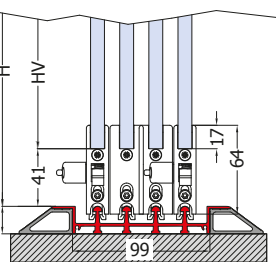

LG-420-N-SET 5

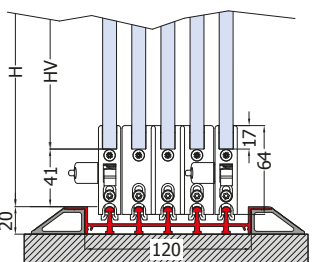

set 2 set 2 + set 2

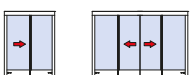

set 3 set 3 + set 3

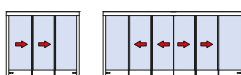

set 4 set 4 + set 4

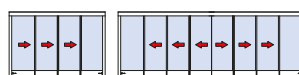

set 5 set 5 + set 5

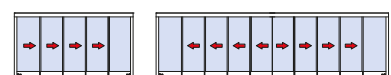

LOGGIAGLAS LG-400-N SET 2

SCORREVOLE TELESCOPICO / TELESCOPIC SLIDING SYSTEM / TELESKOP SCHIEBETÜRSYSTEM

- SISTEMA CON GUIDA A TERRA: Sistema scorrevole telescopico studiato per balconi, logge e verande, ideale per proteggersi da vento e intemperie.
- SYSTEMS WITH BOTTOM GUIDE: Telescopic sliding system for balconies, loggias and terraces, ideal for wind and weather protection.
- SYSTEM MIT BODENFÜHRUNG: Teleskop Schiebetürsystem für Balkon und Loggiaverglasungen, ideal für Wind-und Wetterschutz.



COMPONENTI / COMPONENTS / EINZELTEILE



LOGGIAGLAS LG-400-N SET 3

SCORREVOLE TELESCOPICO / TELESCOPIC SLIDING SYSTEM / TELESKOP SCHIEBETÜRSYSTEM

- SISTEMA CON GUIDA A TERRA: Sistema scorrevole telescopico studiato per balconi, logge e verande, ideale per proteggersi da vento e intemperie.
- SYSTEMS WITH BOTTOM GUIDE: Telescopic sliding system for balconies, loggias and terraces, ideal for wind and weather protection.
- SYSTEM MIT BODENFÜHRUNG: Teleskop Schiebetürsystem für Balkon und Loggiaverglasungen, ideal für Wind-und Wetterschutz.



COMPONENTI / COMPONENTS / EINZELTEILE



LG-400-8-N	LG-400-N
70 Kg 8 950	70 Kg 10 950

2 ruote per anta / 2 wheels each panel / 2 Rollen je Flügel

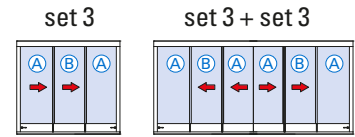

LG-400-N

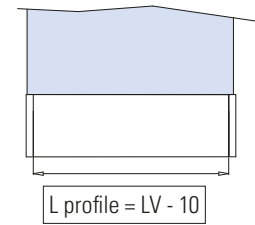
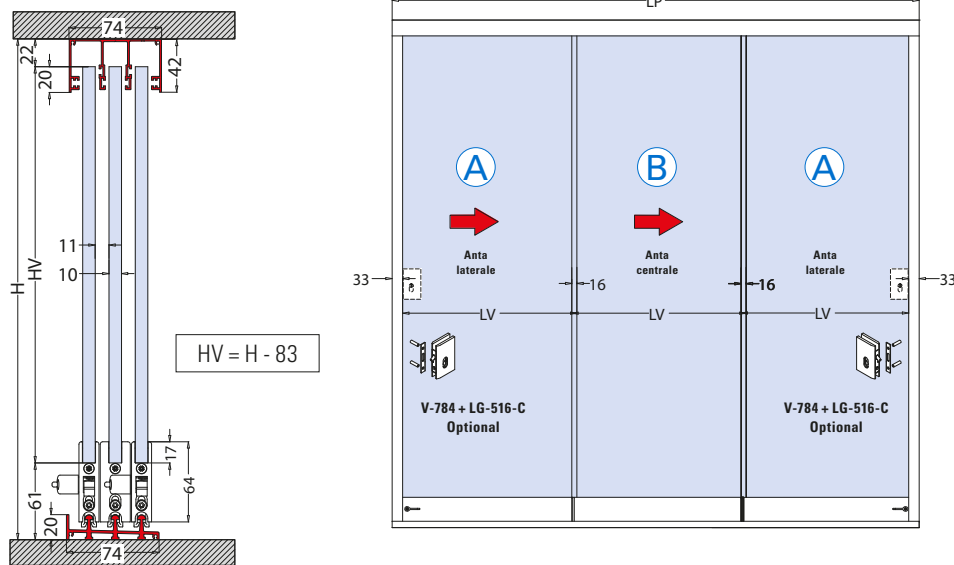

LG-410-N

- Set con guida inferiore incassata
- Set with recessed floor profile
- Set mit versenkter Bodenschiene

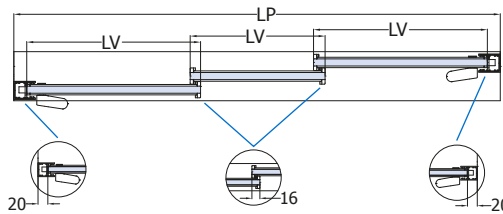
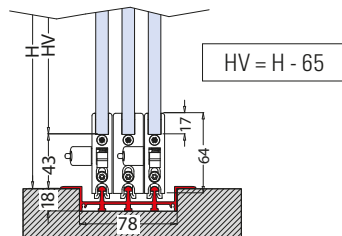

LG-420-N

- Set con guida a terra in appoggio e profili a scivolo
- Set with bottom rail and ramp profiles
- Set mit Bodenschiene und Profile Rampe

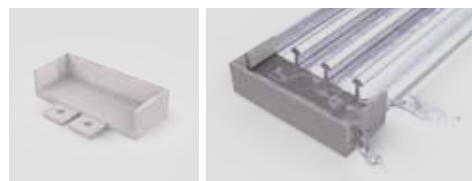
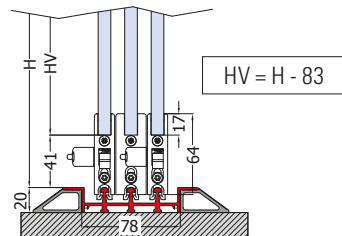

LG-533 (OPTIONAL)

- Sistema scarico acqua laterale per la guida inferiore 3 vie
- Side drainage system for 3-ways floor profile
- Seitliches Entwässerungssystem für 3-läufige Bodenschiene

- Taglio guida a terra = Bottom rail length = Länge Bodenschiene = LP - 64

LG-533

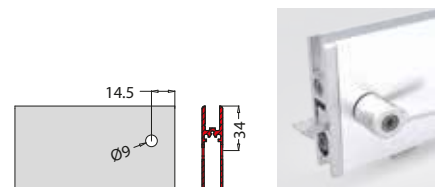
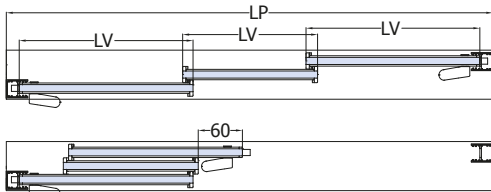

- Lavorazione profilo anta per catenacciolo LG-511 / LG-512
- Preparation panel profile for Locking bolt LG-511 / LG-512
- Profilbearbeitung für Feststellriegel LG-511 / LG-512

FORMULE CALCOLO VETRI VEDI PAG 177
CALCULATION GLASS SEE PAGE 177
GLASBERECHNUNG SIEHE SEITE 177

LP Passaggio luce Clear opening width Lichte Durchgangsbreite	LV Larghezza vetro Glass width Glas Breite	H Altezza passaggio luce Clear opening height Lichte Durchgangshöhe	HV Altezza vetro Glass height Glas Höhe	AN Alluminio anodizzato Aluminium anodized Aluminium Silberfarbig	BI Bianco Ral 9010 White Ral 9010 Weiss Ral 9010
---	--	---	---	---	--

xme622c

LOGGIAGLAS LG-400-N SET 4

SCORREVOLE TELESCOPICO / TELESCOPIC SLIDING SYSTEM / TELESKOP SCHIEBETÜRSYSTEM

- SISTEMA CON GUIDA A TERRA: Sistema scorrevole telescopico studiato per balconi, logge e verande, ideale per proteggersi da vento e intemperie.
- SYSTEMS WITH BOTTOM GUIDE: Telescopic sliding system for balconies, loggias and terraces, ideal for wind and weather protection.
- SYSTEM MIT BODENFÜHRUNG: Teleskop Schiebetürsystem für Balkon und Loggiaverglasungen, ideal für Wind-und Wetterschutz.



COMPONENTI / COMPONENTS / EINZELTEILE



LG-504-N

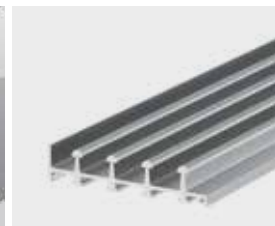

LG-506

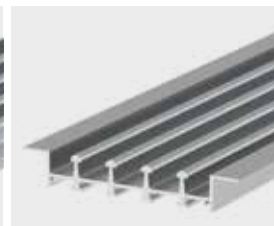

LG-507

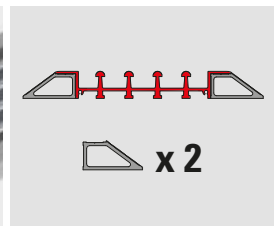

LG-527-CF2



LG-405



LG-508



LG-409



LG-410



LG-511

LG-400-8-N	LG-400-N
2 ruote per anta / 2 wheels each panel / 2 Rollen je Flügel	

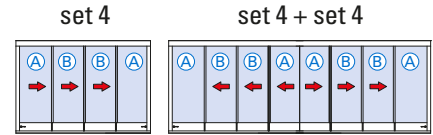

LG-400-N

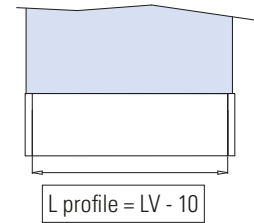
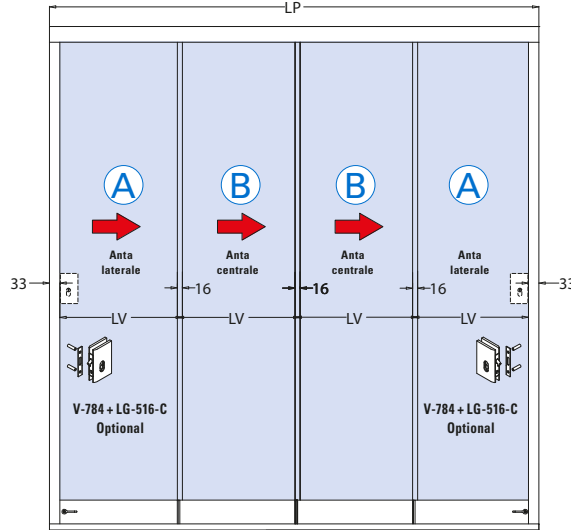
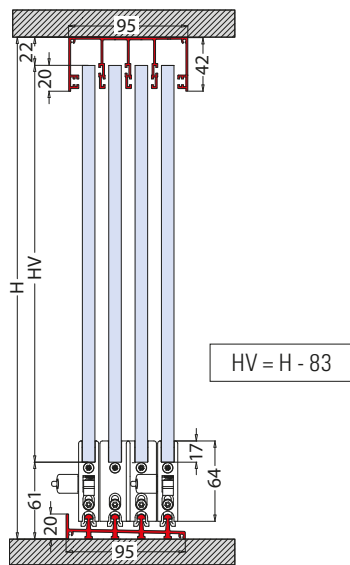

LG-410-N

- Set con guida inferiore incassata
- Set with recessed floor profile
- Set mit versenkter Bodenschiene

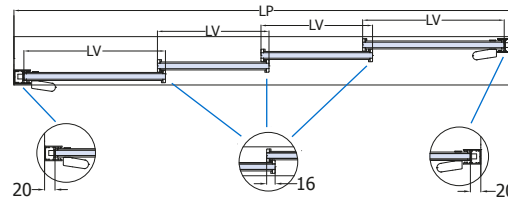
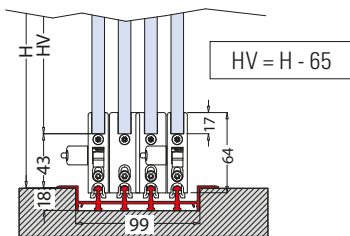

LG-420-N

- Set con guida a terra in appoggio e profili a scivolo
- Set with bottom rail and ramp profiles
- Set mit Bodenschiene und Profile Rampe

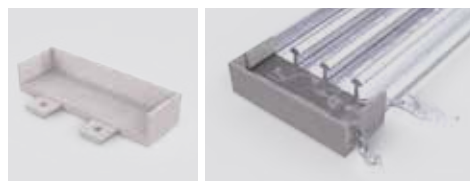
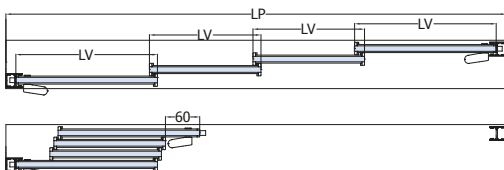
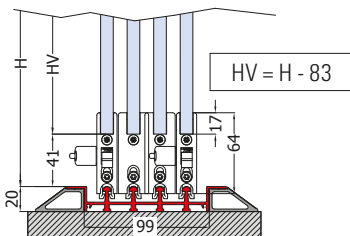

LG-534 (OPTIONAL)

- Sistema scarico acqua laterale per la guida inferiore 4 vie
- Side drainage system for 4-ways floor profile
- Seitliches Entwässerungssystem für 4-läufige Bodenschiene

- Taglio guida a terra =
- Bottom rail length =
- Länge Bodenschiene =

LP - 64

LG-534

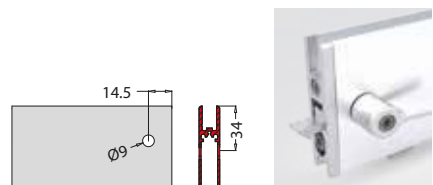

- Lavorazione profilo anta per catenacciolo LG-511 / LG-512
- Preparation panel profile for Locking bolt LG-511 / LG-512
- Profilbearbeitung für Feststellriegel LG-511 / LG-512

FORMULE CALCOLO VETRI VEDI PAG 178
CALCULATION GLASS SEE PAGE 178
GLASBERECHNUNG SIEHE SEITE 178

LP Passaggio luce Clear opening width Lichte Durchgangsbreite	LV Larghezza vetro Glass width Glass Breite	H Altezza passaggio luce Clear opening height Lichte Durchgangshöhe	HV Altezza vetro Glass height Glass Höhe	AN Alluminio anodizzato Aluminium anodized Aluminium Silberfarbig	BI Bianco Ral 9010 White Ral 9010 Weiss Ral 9010
---	---	---	--	---	--

xme622d

LOGGIAGLAS LG-400-N SET 5

SCORREVOLE TELESCOPICO / TELESCOPIC SLIDING SYSTEM / TELESKOP SCHIEBETÜRSYSTEM

- SISTEMA CON GUIDA A TERRA: Sistema scorrevole telescopico studiato per balconi, logge e verande, ideale per proteggersi da vento e intemperie.
- SYSTEMS WITH BOTTOM GUIDE: Telescopic sliding system for balconies, loggias and terraces, ideal for wind and weather protection.
- SYSTEM MIT BODENFÜHRUNG: Teleskop Schiebetürsystem für Balkon und Loggiaverglasungen, ideal für Wind-und Wetterschutz.



COMPONENTI / COMPONENTS / EINZELTEILE



LG-400-8-N	LG-400-N	
2 ruote per anta / 2 wheels each panel / 2 Rollen je Flügel		

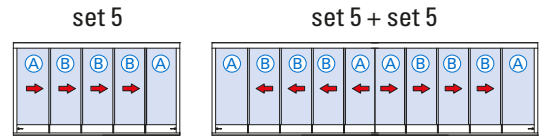

LG-400-N

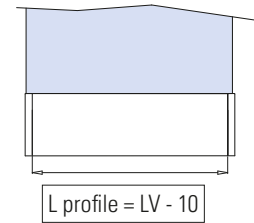
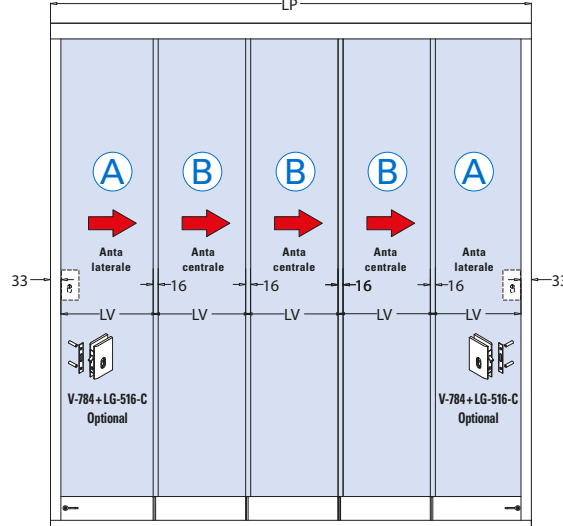
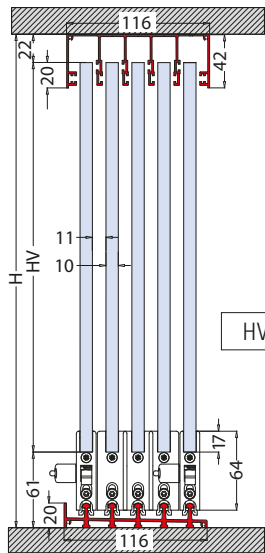

LG-410-N

- Set con guida inferiore incassata
- Set with recessed floor profile
- Set mit versenkter Bodenschiene

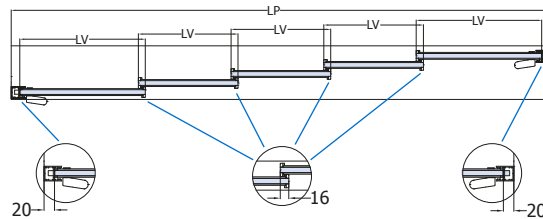
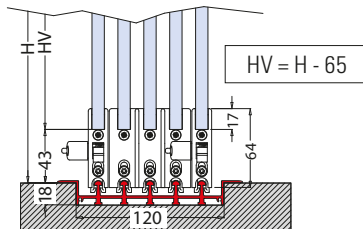

LG-420-N

- Set con guida a terra in appoggio e profili a scivolo
- Set with bottom rail and ramp profiles
- Set mit Bodenschiene und Profile Rampe

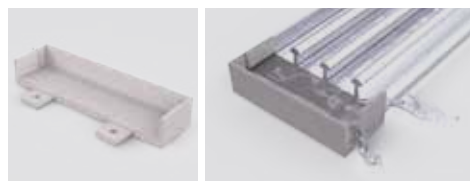
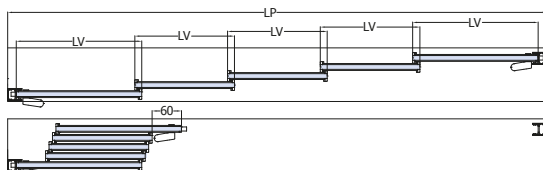
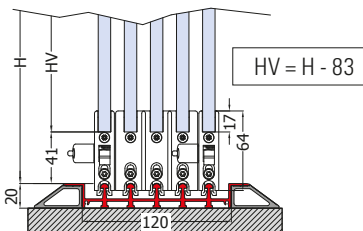

LG-535 (OPTIONAL)

- Sistema scarico acqua laterale per la guida inferiore 5 vie
- Side drainage system for 5-ways floor profile
- Seitliches Entwässerungssystem für 5-läufige Bodenschiene

- Taglio guida a terra =
- Bottom rail length =
- Länge Bodenschiene =

LP - 64

LG-535

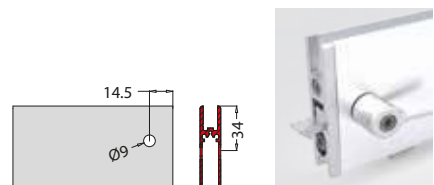

- Lavorazione profilo anta per catenacciolo LG-511 / LG-512
- Preparation panel profile for Locking bolt LG-511 / LG-512
- Profilbearbeitung für Feststellriegel LG-511 / LG-512

FORMULE CALCOLO VETRI VEDI PAG 179
CALCULATION GLASS SEE PAGE 179
GLASBERECHNUNG SIEHE SEITE 179

LP Passaggio luce Clear opening width Lichte Durchgangsbreite	LV Larghezza vetro Glass width Glas Breite	H Altezza passaggio luce Clear opening height Lichte Durchgangshöhe	HV Altezza vetro Glass height Glas Höhe	AN Alluminio anodizzato Aluminium anodized Aluminium Silberfarbig	BI Bianco Ral 9010 White Ral 9010 Weiss Ral 9010
---	--	---	---	---	--

xme622e

LOGGIAGLAS LG-400-N SET 2

CALCOLO VETRI / GLASS CALCULATION / GLASBERECHNUNG

LG-400-N-C2

- Formula calcolo larghezza ante **con** catenaccioli o serrature e **con** montanti laterali LG-508
- Glass calculation **with** locking bolts or locks and **with** "U" side profile LG-508
- Glasberechnung **mit** Feststellriegel oder Schloss und **mit** "U"-seitlichem Profil LG-508

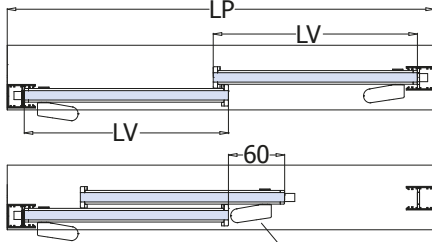

SET 2

$$LV = LP / 2$$

$$LV \text{ Anta Laterale } A = LV - 11$$

SET 2 + SET 2

$$LV = LP / 4$$

$$LV \text{ Anta Laterale } A = LV$$

LG-400-N

- Formula calcolo larghezza ante **senza** catenaccioli o serrature e **senza** montanti laterali LG-508
- Glass calculation **without** locking bolts or locks and **without** "U" side profile LG-508
- Glasberechnung **ohne** Feststellriegel bzw. Schloss und **ohne** "U"-seitliches Profil LG-508

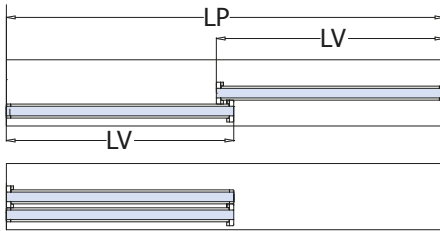

SET 2

$$LV = LP / 2$$

$$LV \text{ Anta Laterale } A = LV + 10$$

SET 2 + SET 2

$$LV = LP / 4$$

$$LV \text{ Anta Laterale } A = LV + 10$$

LG-400-N

- Formula calcolo larghezza ante **senza** catenaccioli e **senza** montanti laterali LG-508, **con** serratura V-784
- Glass calculation **without** locking bolts and **without** "U" side profile LG-508, **with** locks V-784
- Glasberechnung **ohne** Feststellriegel und **ohne** "U"-seitliches Profil LG-508, **mit** Schloss V-784

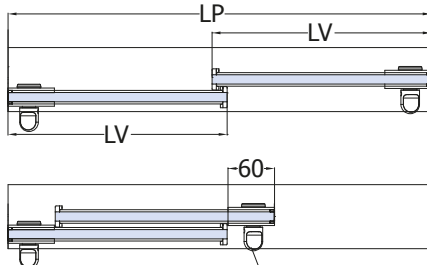

SET 2

$$LV = LP / 2$$

$$LV \text{ Anta Laterale } A = LV + 9$$

SET 2 + SET 2

$$LV = LP / 4$$

$$LV \text{ Anta Laterale } A = LV + 9$$

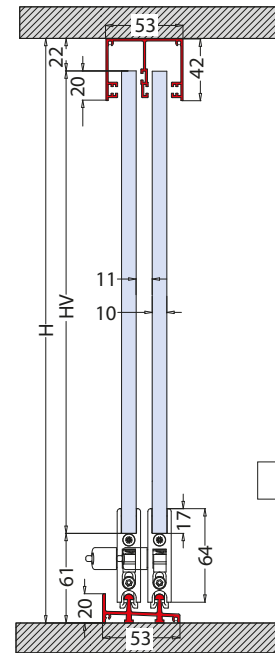

LG-410-N

- Set con guida inferiore incassata
- Set with recessed floor profile
- Set mit versenkter Bodenschiene

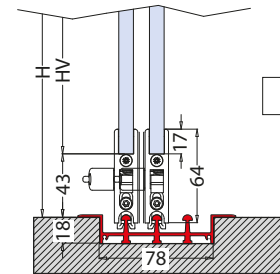

LG-420-N

- Set con guida a terra in appoggio e profili a scivolo
- Set with bottom rail and ramp profiles
- Set mit Bodenschiene und Profile Rampe

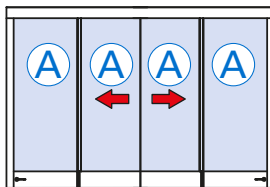
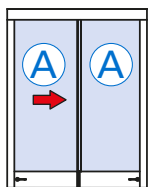
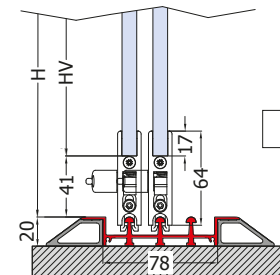

LP
Passaggio luce
Clear opening width
Lichte Durchgangsbreite

LV
Larghezza vetro
Glass width
Glas Breite

H
Altezza passaggio luce
Clear opening height
Lichte Durchgangshöhe

HV
Altezza vetro
Glass height
Glas Höhe

LOGGIAGLAS LG-400-N SET 3

CALCOLO VETRI / GLASS CALCULATION / GLASBERECHNUNG

LG-400-N-C2

- Formula calcolo larghezza ante **con** catenaccioli o serrature e **con** montanti laterali LG-508
- Glass calculation **with** locking bolts or locks and **with** "U" side profile LG-508
- Glasberechnung **mit** Feststellriegel oder Schloss und **mit** "U"-seitlichem Profil LG-508

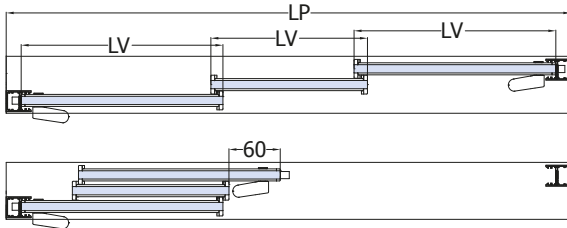

SET 3

$$LV = LP / 3$$

$$LV \text{ Anta Laterale A} = LV + 18$$

$$LV \text{ Anta Centrale B} = LV - 42$$

SET 3 + SET 3

$$LV = LP / 6$$

$$LV \text{ Anta Laterale A} = LV + 25$$

$$LV \text{ Anta Centrale B} = LV - 35$$

LG-400-N

- Formula calcolo larghezza ante **senza** catenaccioli o serrature e **senza** montanti laterali LG-508
- Glass calculation **without** locking bolts or locks and **without** "U" side profile LG-508
- Glasberechnung **ohne** Feststellriegel bzw. Schloss und **ohne** "U"-seitliches Profil LG-508

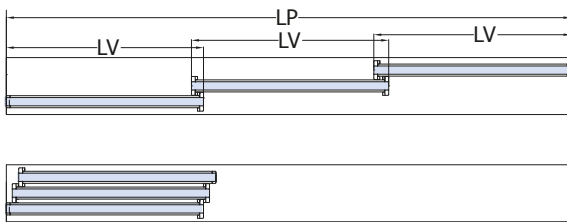

SET 3

$$LV = LP / 3$$

$$LV \text{ Anta Laterale A} = LV + 12$$

$$LV \text{ Anta Centrale B} = LV + 12$$

SET 3 + SET 3

$$LV = LP / 6$$

$$LV \text{ Anta Laterale A} = LV + 12$$

$$LV \text{ Anta Centrale B} = LV + 12$$

LG-400-N

- Formula calcolo larghezza ante **senza** catenaccioli e **senza** montanti laterali LG-508, **con** serratura V-784
- Glass calculation **without** locking bolts and **without** "U" side profile LG-508, **with** locks V-784
- Glasberechnung **ohne** Feststellriegel und **ohne** "U"-seitliches Profil LG-508, **mit** Schloss V-784

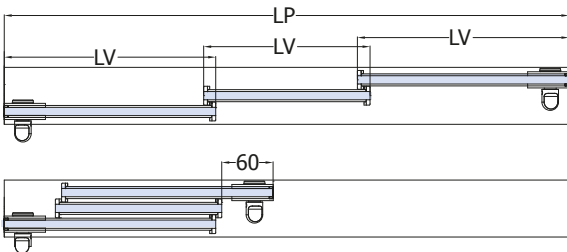

SET 3

$$LV = LP / 3$$

$$LV \text{ Anta Laterale A} = LV + 31$$

$$LV \text{ Anta Centrale B} = LV - 29$$

SET 3 + SET 3

$$LV = LP / 6$$

$$LV \text{ Anta Laterale A} = LV + 31$$

$$LV \text{ Anta Centrale B} = LV - 29$$

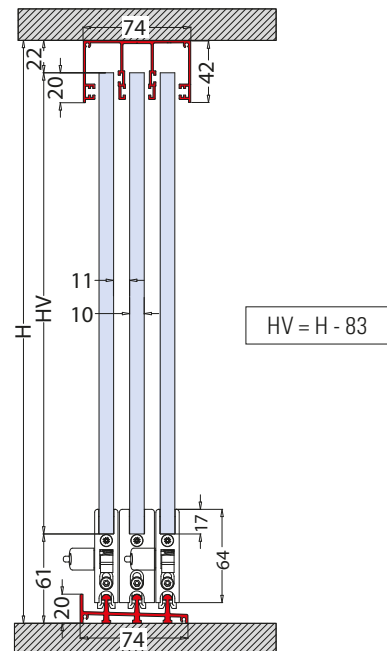

$$HV = H - 83$$

LG-410-N

- Set con guida inferiore incassata
- Set with recessed floor profile
- Set mit versenkter Bodenschiene

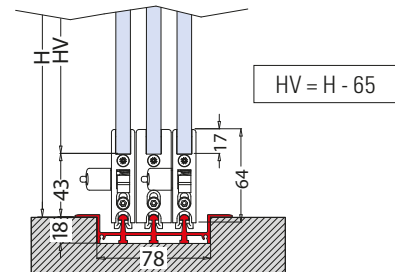

$$HV = H - 65$$

LG-420-N

- Set con guida a terra in appoggio e profili a scivolo
- Set with bottom rail and ramp profiles
- Set mit Bodenschiene und Profile Rampe

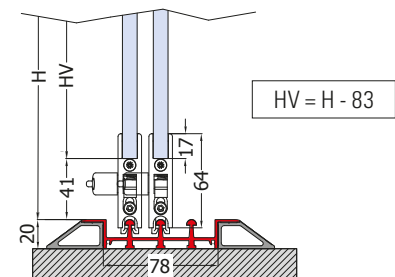

$$HV = H - 83$$

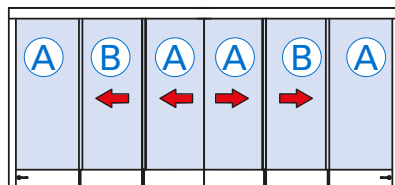
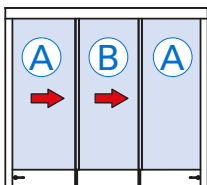

LP
Passaggio luce
Clear opening width
Lichte Durchgangsbreite

LV
Larghezza vetro
Glass width
Glass Breite

H
Altezza passaggio luce
Clear opening height
Lichte Durchgangshöhe

HV
Altezza vetro
Glass height
Glass Höhe

LOGGIAGLAS LG-400-N SET 4

CALCOLO VETRI / GLASS CALCULATION / GLASBERECHNUNG

LG-400-N-C2

- Formula calcolo larghezza ante **con** catenaccioli o serrature e **con** montanti laterali LG-508
- Glass calculation **with** locking bolts or locks and **with** "U" side profile LG-508
- Glasberechnung **mit** Feststellriegel oder Schloss und **mit** "U"-seitlichem Profil LG-508

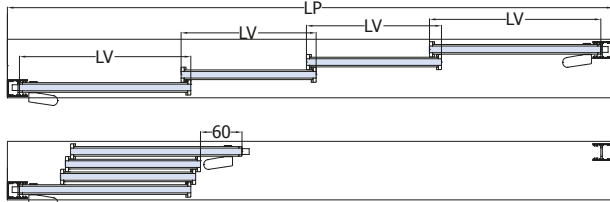

SET 4

$$LV = LP / 4$$

$$LV \text{ Anta Laterale A} = LV + 33$$

$$LV \text{ Anta Centrale B} = LV - 27$$

SET 4 + SET 4

$$LV = LP / 8$$

$$LV \text{ Anta Laterale A} = LV + 38$$

$$LV \text{ Anta Centrale B} = LV - 22$$

LG-400-N

- Formula calcolo larghezza ante **senza** catenaccioli o serrature e **senza** montanti laterali LG-508
- Glass calculation **without** locking bolts or locks and **without** "U" side profile LG-508
- Glasberechnung **ohne** Feststellriegel bzw. Schloss und **ohne** "U"-seitliches Profil LG-508

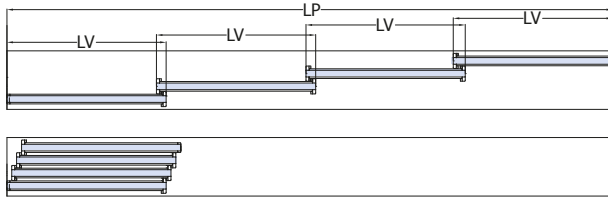

SET 4

$$LV = LP / 4$$

$$LV \text{ Anta Laterale A} = LV + 13$$

$$LV \text{ Anta Centrale B} = LV + 13$$

SET 4 + SET 4

$$LV = LP / 8$$

$$LV \text{ Anta Laterale A} = LV + 13$$

$$LV \text{ Anta Centrale B} = LV + 13$$

LG-400-N

- Formula calcolo larghezza ante **senza** catenaccioli e **senza** montanti laterali LG-508, **con** serratura V-784
- Glass calculation **without** locking bolts and **without** "U" side profile LG-508, **with** locks V-784
- Glasberechnung **ohne** Feststellriegel und **ohne** "U"-seitliches Profil LG-508, **mit** Schloss V-784

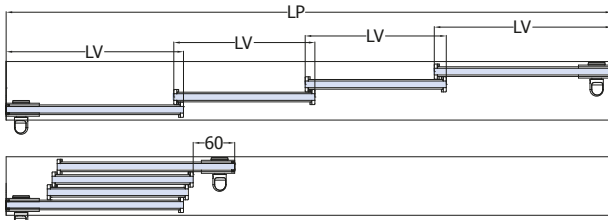

SET 4

$$LV = LP / 4$$

$$LV \text{ Anta Laterale A} = LV + 43$$

$$LV \text{ Anta Centrale B} = LV - 17$$

SET 4 + SET 4

$$LV = LP / 8$$

$$LV \text{ Anta Laterale A} = LV + 43$$

$$LV \text{ Anta Centrale B} = LV - 17$$

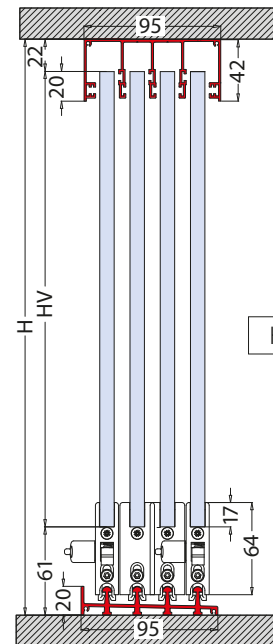

$$HV = H - 83$$

LG-410-N

- Set con guida inferiore incassata
- Set with recessed floor profile
- Set mit versenkter Bodenschiene

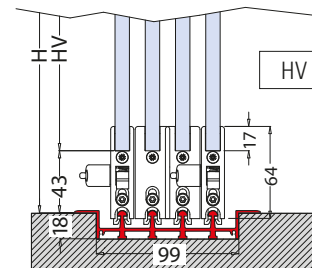

$$HV = H - 65$$

LG-420-N

- Set con guida a terra in appoggio e profili a scivolo
- Set with bottom rail and ramp profiles
- Set mit Bodenschiene und Profile Rampe

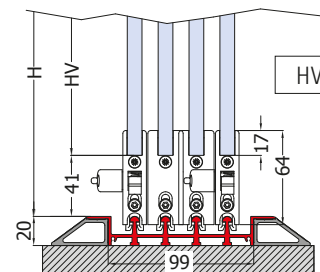

$$HV = H - 83$$

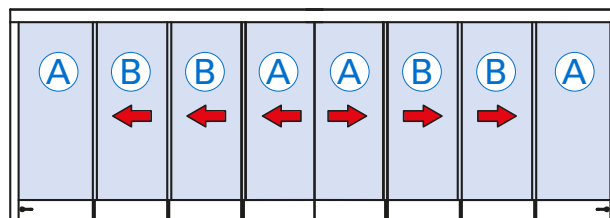
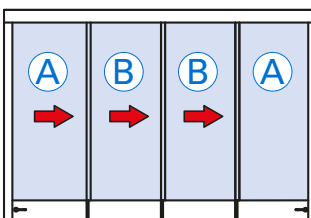

LP
Passaggio luce
Clear opening width
Lichte Durchgangsbreite

LV
Larghezza vetro
Glass width
Glas Breite

H
Altezza passaggio luce
Clear opening height
Lichte Durchgangshöhe

HV
Altezza vetro
Glass height
Glas Höhe

LOGGIAGLAS LG-400-N SET 5

CALCOLO VETRI / GLASS CALCULATION / GLASBERECHNUNG

LG-400-N-C2

- Formula calcolo larghezza ante **con** catenaccioli o serrature e **con** montanti laterali LG-508
- Glass calculation **with** locking bolts or locks and **with** "U" side profile LG-508
- Glasberechnung **mit** Feststellriegel oder Schloss und **mit** "U"-seitlichem Profil LG-508

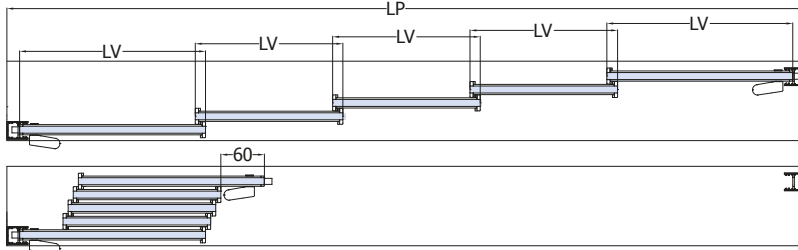

SET 5

LV = LP / 5
LV Anta Laterale A = LV + 41
LV Anta Centrale B = LV - 19

SET 5 + SET 5

LV = LP / 10
LV Anta Laterale A = LV + 45
LV Anta Centrale B = LV - 15

LG-400-N

- Formula calcolo larghezza ante **senza** catenaccioli o serrature e **senza** montanti laterali LG-508
- Glass calculation **without** locking bolts or locks and **without** "U" side profile LG-508
- Glasberechnung **ohne** Feststellriegel bzw. Schloss und **ohne** "U"-seitliches Profil LG-508

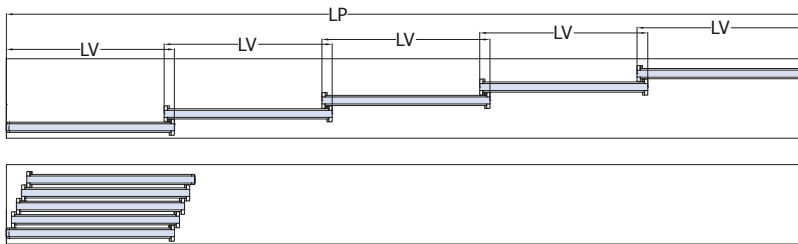

SET 5

LV = LP / 5
LV Anta Laterale A = LV + 13
LV Anta Centrale B = LV + 13

SET 5 + SET 5

LV = LP / 10
LV Anta Laterale A = LV + 13
LV Anta Centrale B = LV + 13

LG-400-N

- Formula calcolo larghezza ante **senza** catenaccioli e **senza** montanti laterali LG-508, **con** serratura V-784
- Glass calculation **without** locking bolts and **without** "U" side profile LG-508, **with** locks V-784
- Glasberechnung **ohne** Feststellriegel und **ohne** "U"-seitliches Profil LG-508, **mit** Schloss V-784

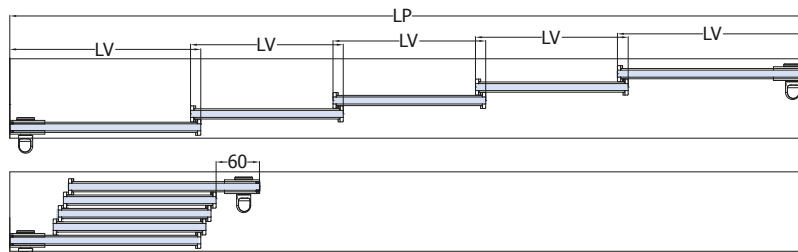

SET 5

LV = LP / 5
LV Anta Laterale A = LV + 49
LV Anta Centrale B = LV - 11

SET 5 + SET 5

LV = LP / 10
LV Anta Laterale A = LV + 49
LV Anta Centrale B = LV - 11

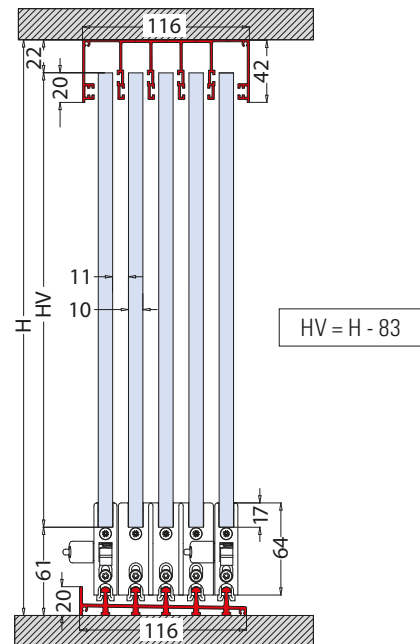

HV = H - 83

LG-410-N

- Set con guida inferiore incassata
- Set with recessed floor profile
- Set mit versenkter Bodenschiene

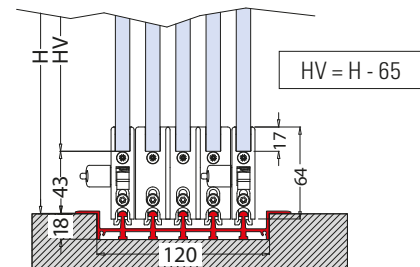

HV = H - 65

LG-420-N

- Set con guida a terra in appoggio e profili a scivolo
- Set with bottom rail and ramp profiles
- Set mit Bodenschiene und Profile Rampe

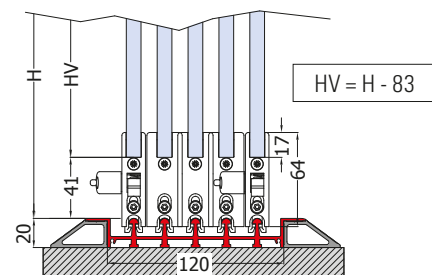

HV = H - 83

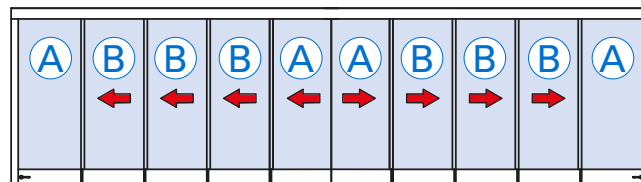
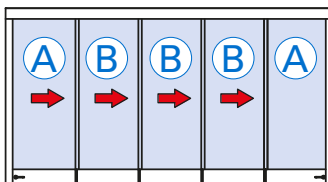

LP
Passaggio luce
Clear opening width
Lichte Durchgangsbreite

LV
Larghezza vetro
Glass width
Glas Breite

H
Altezza passaggio luce
Clear opening height
Lichte Durchgangshöhe

HV
Altezza vetro
Glass height
Glas Höhe

LOGGIAGLAS

ACCESSORI / ACCESSORIES / ZUBEHÖRE



LG-528-N

- Binario superiore 2 vie, setola non inclusa
- Track profile 2-ways, brush seal not included
- Laufschienenprofil 2-gleisig, Bürstendichtungen nicht enthalten

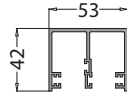

LG-529

- Guida inferiore 2 vie
- Floor profile 2-ways
- Bodenschiene 2-gleisig

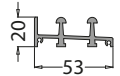

LG-501-N

- Binario superiore 3 vie, setola non inclusa
- Track profile 3-ways, brush seal not included
- Laufschienenprofil 3-gleisig, Bürstendichtungen nicht enthalten

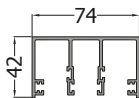

LG-502

- Guida inferiore 3 vie
- Floor profile 3-ways
- Bodenschiene 3-gleisig

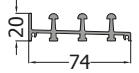

LG-504-N

- Binario superiore 4 vie, setola non inclusa
- Track profile 4-ways, brush seal not included
- Laufschienenprofil 4-gleisig, Bürstendichtungen nicht enthalten

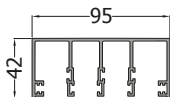

LG-503

- Guida inferiore incassata 3 vie
- Recessed floor profile 3-ways
- Versenkte Bodenschiene 3-gleisig

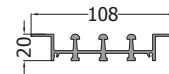

LG-513-N

- Binario superiore 5 vie, setola non inclusa
- Track profile 5-ways, brush seal not included
- Laufschienenprofil 5-gleisig, Bürstendichtungen nicht enthalten

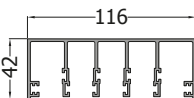

LG-506

- Guida inferiore 4 vie
- Floor profile 4-ways
- Bodenschiene 4-gleisig

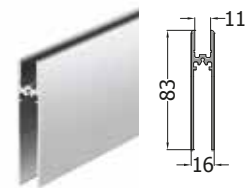
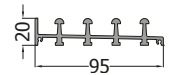

LG-505

- Profilo anta per sistemi LG-500, per vetro 8/10 mm. Foro catenacciolo a carico cliente
- Horizontal panel profile for systems LG-500 for glass 8/10 mm. Hole for locking bolt by customer
- Horizontal Profil für Türen für Systeme LG-500 für Glas 8/10 mm. Bohrung für Feststeller bauseits

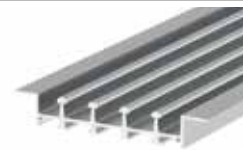
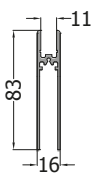

LG-507

- Guida inferiore incassata 4 vie
- Recessed floor profile 4-ways
- Versenkte Bodenschiene 4-gleisig

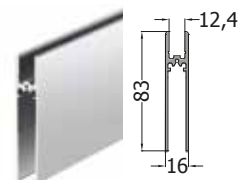
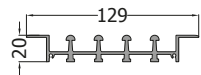

LG-505-12

- Profilo anta per sistemi LG-500, per vetro 12 mm. Foro catenacciolo a carico cliente
- Horizontal panel profile for systems LG-500 for glass 12 mm. Hole for locking bolt by customer
- Horizontal Profil für Türen für Systeme LG-500 für Glas 12 mm. Bohrung für Feststeller bauseits

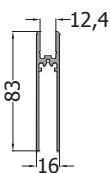

LG-514

- Guida inferiore 5 vie
- Floor profile 5-ways
- Bodenschiene 5-gleisig

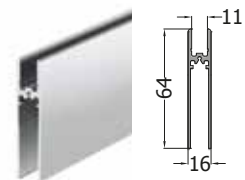
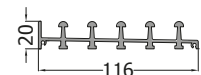

LG-405

- Profilo anta per sistemi LG-400, per vetro 8/10 mm. Foro catenacciolo a carico cliente
- Horizontal panel profile for systems LG-400 for glass 8/10 mm. Hole for locking bolt by customer
- Horizontal Profil für Türen für Systeme LG-400 für Glas 8/10 mm. Bohrung für Feststeller bauseits

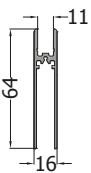

LG-515

- Guida inferiore incassata 5 vie
- Recessed floor profile 5-ways
- Versenkte Bodenschiene 5-läufig

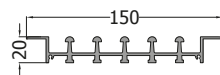

LG-508

- Montante laterale ad "U", setola non inclusa
- "U" side profile, brush seals not included
- "U"-seitliches Profil, Bürstendichtungen nicht enthalten

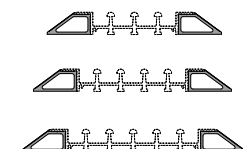
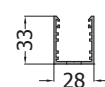

LG-527-CF2

- Scivolo per LG-503, LG-507 e LG-515
- Ramp for LG-503, LG-507 and LG-515
- Rampe für LG-503, LG-507 und LG-515

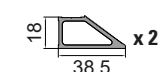

LOGGIAGLAS LG-500-N CARRELLI / ROLLERS / LAUFWAGEN

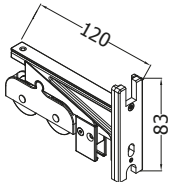

- LG-509**
LG-509-12 (for glass 12 mm)
- Carrello con bilanciere a 2 ruote con funzione di trascinamento
 - Seesaw roller with 2 wheels and with dragging function
 - Wippenlaufwagen mit 2 Räder und mit Mitnehmer Funktion

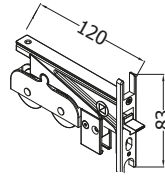

- LG-510**
LG-510-12 (for glass 12 mm)
- Catenacciolo / carrello con bilanciere a 2 ruote
 - Locking bolt seesaw roller with 2 wheels
 - Feststeller Wippenlaufwagen mit 2 Räder

LG-521

- Carrello con bilanciere a 2 ruote e contropiastra per catenacciolo LG-510 con set doppio
- Seesaw roller with 2 wheels and strike plate for locking bolt LG-510 with double set
- Wippenlaufwagen mit 2 Räder und Schließblech für Feststeller LG-510 mit doppel Set

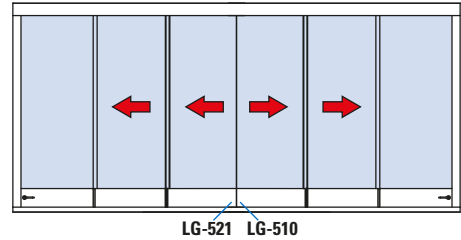
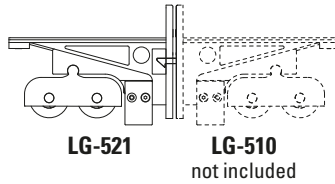
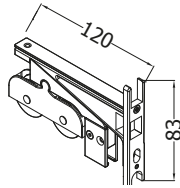

LOGGIAGLAS LG-400-N CARRELLI / ROLLERS / LAUFWAGEN

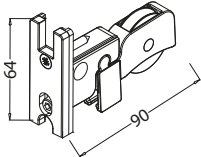

- LG-409**
- Carrello con 1 ruota con funzione di trascinamento
 - Roller with 1 wheel and with dragging function
 - Laufwagen mit 1 Rad und mit Mitnehmer Funktion

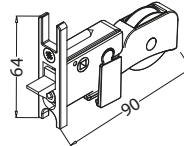

- LG-410**
- Catenacciolo / carrello con 1 ruota
 - Locking bolt roller with 1 wheel
 - Feststeller Laufwagen mit 1 Rad

LG-421

- Carrello con 1 ruota e contropiastra per catenacciolo LG-410 con set doppio
- Roller with 1 wheel and strike plate for locking bolt LG-410 with double set
- Laufwagen mit 1 Rad und Schließblech für Feststeller LG-410 mit doppel Set

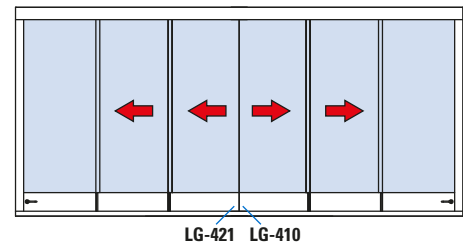
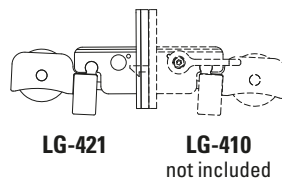
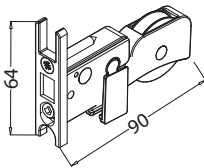

LOGGIAGLAS CONTROPIASTRE / STRIKE PLATE / SCHLIEßBLECH

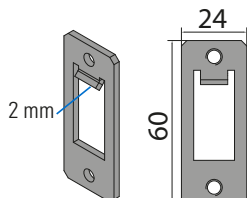



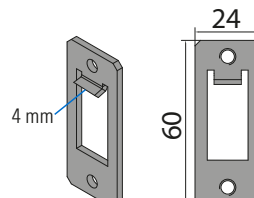





- LG-516-B**
- Contropiastra per serrature V-574, V-794, V-794-LG e carrello LG-510 con montante LG-508
 - Strike plate for lock V-574, V-794, V-794-LG and roller LG-510 with "U" side profile LG-508
 - Schließblech für Schlösser V-574, V-794, V-794-LG und Laufwagen LG-510 mit "U"-seitlichem Profil LG-508

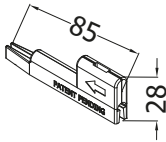
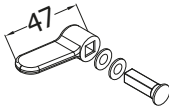
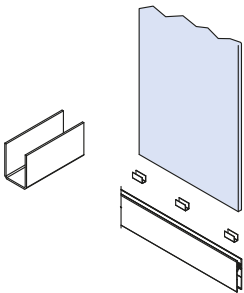
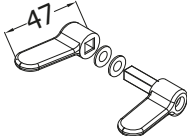
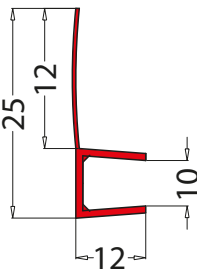
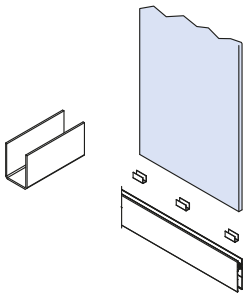
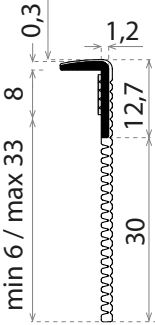
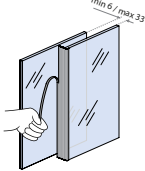

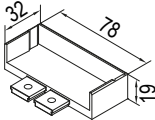
- LG-516-C**
- Contropiastra per serrature V-784, V-784 PO-TC, V-764 e V-764 PO-TC
 - Strike plate for locks V-784, V-784 PO-TC, V-764 and V-764 PO-TC
 - Schließblech für Schlösser V-784, V-784 PO-TC, V-764 und V-764 PO-TC

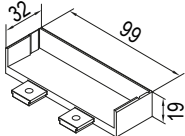
LOGGIAGLAS

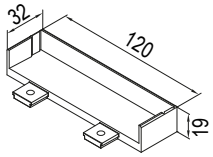
ACCESSORI / ACCESSORIES / ZUBEHÖRE

 <p>LG-517</p> <ul style="list-style-type: none"> • Chiave di manutenzione sgancio ante dal sistema antisollevamento • Maintenance tool to release the panels from the anti-lifting mechanism • Revisionswerkzeug um die Türen aus dem Aushebeschutzsystem zu anheben 	 <p>LG-511</p> <ul style="list-style-type: none"> • Pomolo singolo per catenacciolo • Single knob for locking bolt • Knopf für Feststeller
 <p>LG-526 (CONSIGLIATO - RECOMMENDED - EMPFOHLEN)</p> <ul style="list-style-type: none"> • Set di 3 pcs "U" trasparenti per incollaggio perpendicolare vetro 10 mm al profilo anta LG-505 e LG-405 • Set of 3 pcs transparent "U" support for perpendicular glueing of 10 mm glass to panel profile LG-505 end LG-405 • Set von 3 Stück transparenten U-Auflagen für 10 mm Glas zum passgenauen senkrechten einkleben ins Flügelprofil LG-505 und LG-405 	 <p>LG-512</p> <ul style="list-style-type: none"> • Pomolo doppio per catenacciolo • Double knob for locking bolt • Paar Knöpfe für Feststeller
 <p>LG-518</p> <ul style="list-style-type: none"> • Guarnizione in PVC trasparente per vetro 8/10 mm • Seal in transparent PVC for glass 8/10 mm • PVC Dichtprofil für Glas 8/10 mm 	 <p>LG-426 (CONSIGLIATO - RECOMMENDED - EMPFOHLEN)</p> <ul style="list-style-type: none"> • Set di 3 pcs "U" trasparenti per incollaggio perpendicolare vetro 8 mm al profilo anta LG-405 • Set of 3 pcs transparent "U" support for perpendicular glueing of 8 mm glass to panel profile LG-405 • Set von 3 Stück transparenten U-Auflagen für 8 mm Glas zum passgenauen senkrechten einkleben ins Flügelprofil LG-405
	 <p>V-040-REG</p> <ul style="list-style-type: none"> • Guarnizione per vetro 12 mm aletta laterale accorciabile • Seal for glass 12 mm, side fin can be shortened • Dichtprofil für Glas 12 mm seitliche Lippe kürzbar 
 <p>LG-533</p> <ul style="list-style-type: none"> • Sistema scarico acqua laterale per guida inferiore 3 vie • Side drainage system for 3-ways floor profile • Seitliches Entwässerungssystem für 3-gleisige Bodenschiene 	 <p>LG-534</p> <ul style="list-style-type: none"> • Sistema scarico acqua laterale per guida inferiore 4 vie • Side drainage system for 4-ways floor profile • Seitliches Entwässerungssystem für 4-gleisige Bodenschiene 
 <p>LG-535</p> <ul style="list-style-type: none"> • Sistema scarico acqua laterale per guida inferiore 5 vie • Side drainage system for 5-ways floor profile • Seitliches Entwässerungssystem für 5-gleisige Bodenschiene 	

LOGGIAGLAS

ACCESSORI / ACCESSORIES / ZUBEHÖRE



V-524

- Paio nicchie per scorrevole tonde, Ø 60
- Pair sliding door-handles, Ø 60
- Paar Griffmuscheln, Ø 60

CP - NS - NO



V-532-INC

- Nicchia scorrevole ad incollaggio biadesivo Ø 50
- Sliding door-handle Ø 50 with self adhesive
- Griffmuschel Ø 50 selbstklebend

AN - NS

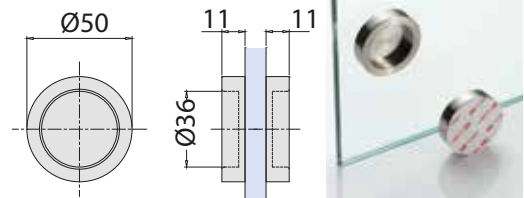

LOGGIAGLAS

ACCESSORI / ACCESSORIES / ZUBEHÖRE

V-784

- Serratura con gancio per scorrevole.
Contropiastra non inclusa
- Lock with hook for sliding doors.
Strike plate not included
- Schloss mit Hakenriegel für Schiebetüren.
Schließblech nicht enthalten.

CP - NS - CR

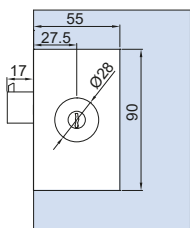

Senza viti a vista
With not visible screws
Ohne sichtbare Schrauben

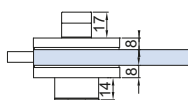

xme520c

V-784 PO-TC

- Serratura con gancio per scorrevole.
Contropiastra non inclusa
- Lock with hook for sliding doors.
Strike plate not included
- Schloss mit Hakenriegel für Schiebetüren.
Schließblech nicht enthalten.

CP - NS

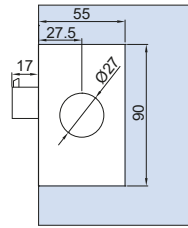

Senza viti a vista
With not visible screws
Ohne sichtbare Schrauben

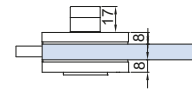

xme520c

V-794

- Serratura con gancio per scorrevole.
Contropiastra non inclusa
- Lock with hook for sliding doors.
Strike plate not included
- Schloss mit Hakenriegel für Schiebetüren.
Schließblech nicht enthalten.

IX - NS*

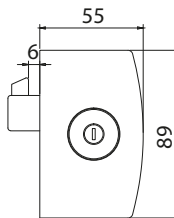

Con viti a vista
With visible screws
Mit sichtbaren Schrauben

V-794-LG

- Serratura con gancio per scorrevole.
Contropiastra non inclusa
- Lock with hook for sliding doors.
Strike plate not included
- Schloss mit Hakenriegel für Schiebetüren.
Schließblech nicht enthalten.

IX - NS*

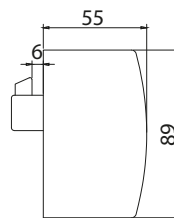

Con viti a vista
With visible screws
Mit sichtbaren Schrauben

V-794-2FLG

- Controserratura
- Strike box
- Gegenkasten

IX - NS*

*NS Fino a esaurimento scorte
Article to be discontinued
Auslaufartikel Lieferbar solange der vorrat reicht.

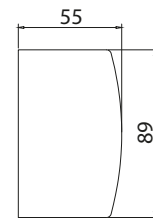

Con viti a vista
With visible screws
Mit sichtbaren Schrauben

LG-516-B

- Contropiastra per serrature V-794, V-794-LG e carrello LG-510 con montante LG-508
- Strike plate for lock V-794, V-794-LG and roller LG-510 with "U" side profile LG-508
- Schließblech für Schlösser V-794, V-794-LG und Laufwagen LG-510 mit "U"-seitlichem Profil LG-508

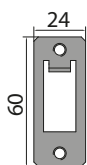

IX

LG-516-C

- Contropiastra per serrature V-784, V-784 PO-TC
- Strike plate for locks V-784, V-784 PO-TC
- Schließblech für Schlösser V-784, V-784 PO-TC

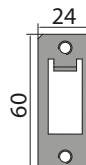

IX

LG-516-D

- Contropiastra per serrature V-774, V-774 PO-TC
- Strike plate for locks V-774, V-774 PO-TC
- Schließblech für Schlösser V-774, V-774 PO-TC

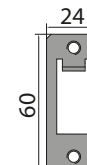

IX

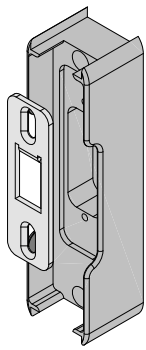

LG-508
Taglio a cura del cliente
Cut by the customer
Schnitt bauseitig

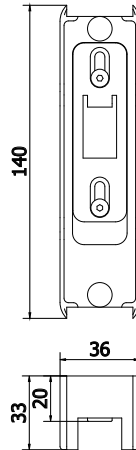
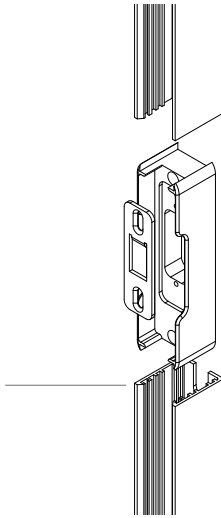

LG-538-2FLG

- Controserratura per montaggio con montanti LG-508 e serrature V-514, V-794, V-774.
- Strike box for installation with wall profiles LG-508 and locks V-514, V-794, V-774.
- Schließblech für Schlösser V-794, V-794-LG und Laufwagen LG-510 mit "U"-seitlichem Profil LG-508

AN

V-784-LG90-400 (Kit for LG-400)

V-784-LG90-500 (Kit for LG-500)

- Controserratura 90° per serrature V-794, V-784, V-764, V-564 e V-574, comprese staffe 90°, tappi per giunzione profili e guarnizione magnetica
- Strike box 90° for locks V-794, V-784, V-764, V-564 and V-574, brackets 90°, endcaps for connecting the profiles and magnetic gasket included
- Gegenkasten 90° für Schlösser V-794, V-784, V-764, V-564 und V-574, Verbindler 90°, Endkappen für Profile und Magnetdichtung enthalten

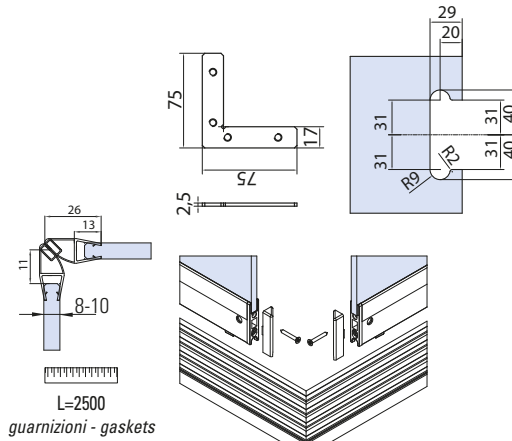
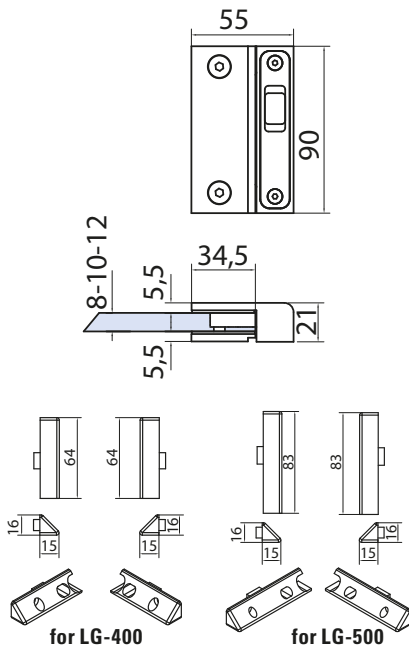

L=2500
guarnizioni - gaskets

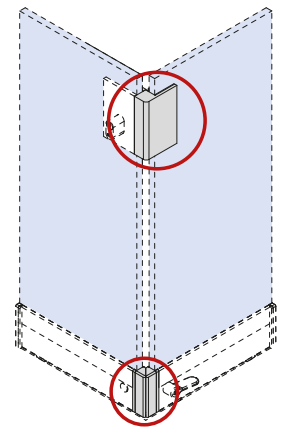

xme629

ALCUNE TIPOLOGIE DI APPLICAZIONE

SOME TYPOLOGIES OF APPLICATIONS

EINIGEN KOMPOSITIONSMÖGLIKEITEN DES SYSTEM





ALCUNE TIPOLOGIE DI APPLICAZIONE

SOME TYPOLOGIES OF APPLICATIONS

EINIGEN KOMPOSITIONSMÖGLIKEITEN DES SYSTEM





ALCUNE TIPOLOGIE DI APPLICAZIONE

SOME TYPOLOGIES OF APPLICATIONS

EINIGEN KOMPOSITIONSMÖGLICHKEITEN DES SYSTEM

